

# Data Sheet



Article number: 0105034

Description: Retaining ring AV 18

Note: Fitted with ZGA pliers

## Measures

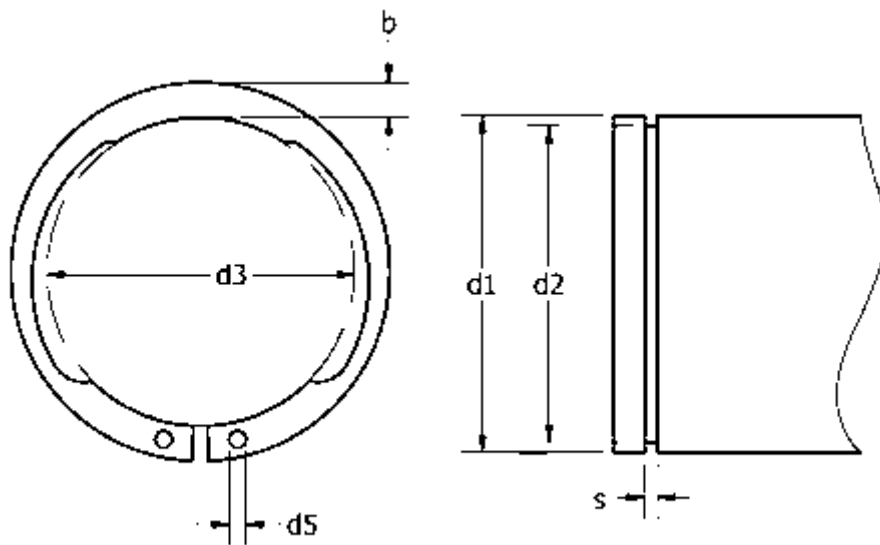

AN mm <sup>2</sup>	= 12.4	FRg kN	= 3.2	t	= 0.50
b	= 2.6	FR kN	= 14.8	tol	= -0.06
d1	= 18	g	= 1.5	tol	= -0.11
d2	= 17.0	K kN-mm	= 32.6	tol	= +0,10-0,36
d3	= 16.50	m min	= 1.30	tol	= 0.1
d5 min	= 1.5	n abl x 1000	= 39	Tong	= ZGA-1
Description	= AV 18	s	= 1.20	Weight kg/1000	= 1.14
FN kN	= 2.07	Side power N at I2	= 1.5		